

Turmdrehkran

Tower Crane / Grue à tour / Gru a torre / Grúa torre
Guindaste de torre / Башенный поворотный кран

280 EC-H 16 FR.tronic®

280 EC-H 16 Litronic®

280 EC-H 12 FR.tronic®

280 EC-H 12 Litronic®

280 EC-H 16 FR.tronic®

280 EC-H 16 Litronic®

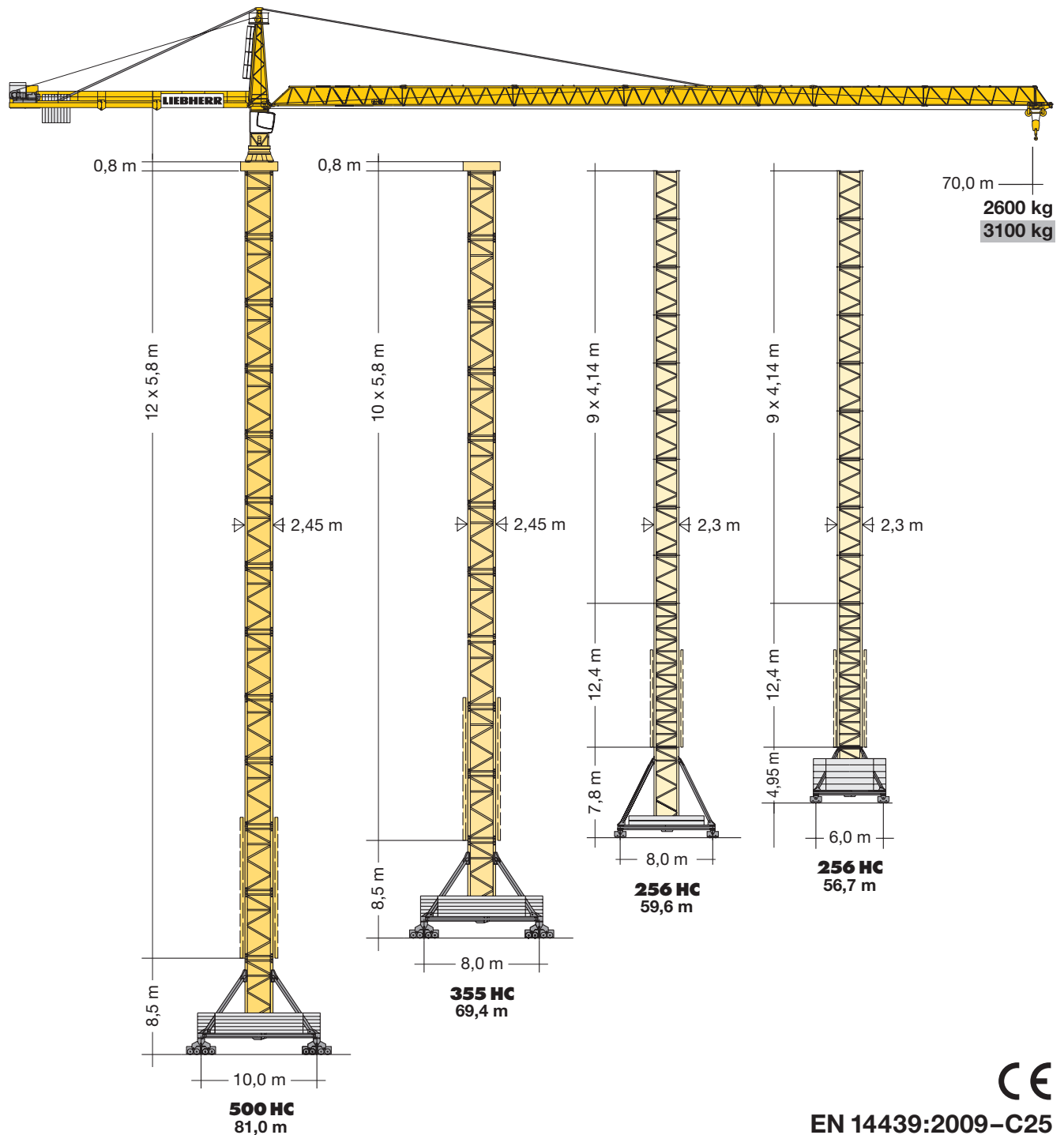

LIEBHERR

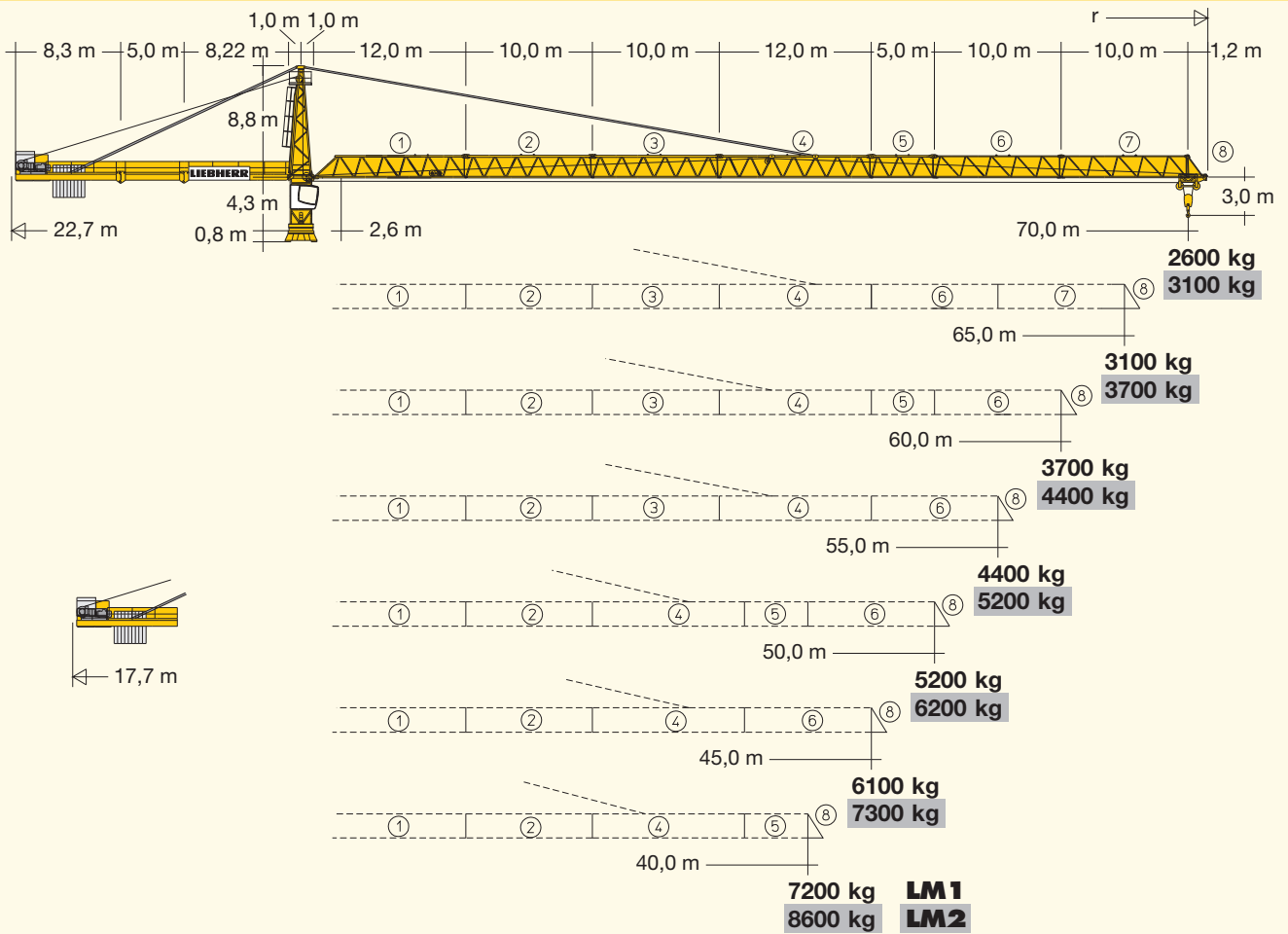

Hubhöhe Hoisting height / Hauteur sous crochet / Altezza di sollevamento Altura bajo gancho / Altura de montagem / Высота подъема

C 25	256 HC			355 HC			500 HC	
	m	m	m	m	m	m	m	m
13	-	-	-	-	-	-	78,7*	-
12	-	-	-	-	-	-	72,9	81,0*
11	-	-	-	67,1*	-	-	67,1	75,2
10	-	-	-	61,3	69,4*	-	61,3	69,4
9	52,0**	56,7**	59,6**	55,5	63,6	-	55,5	63,6
8	47,9*	52,6*	55,5*	49,7	57,8	-	49,7	57,8
7	43,7	48,4	51,3	43,9	52,0	-	43,9	52,0
6	39,6	44,3	47,2	38,1	46,2	-	38,1	46,2
5	35,4	40,1	43,0	32,3	40,4	-	32,3	40,4
4	31,3	36,0	38,9	26,5	34,6	-	26,5	34,6
3	27,2	31,9	34,8	20,7	28,8	-	20,7	28,8
2	23,0	27,7	30,6	14,9	23,0	-	14,9	23,0
1	18,9	23,6	26,5	9,1	17,2	-	9,1	17,2
0	14,7	19,4	22,3	3,3	11,4	-	3,3	11,4

256 HC	355 HC	500 HC

** LM 2 Nicht möglich. / Not possible. / Pas possible. / Non possibile. / No posible. / Nao é possível. / Не возможно.

Weitere Hubhöhen, Auslegerlängen sowie Klettern im Gebäude auf Anfrage. / Further hoist heights and jib lengths as well as climbing inside the building on request. / Autres hauteurs sous crochet et longueurs de flèche ainsi que hissage dans le bâtiment sur demande. / Ulteriori altezze gancho, lunghezze braccio così come telescopaggio all'interno dell'edificio: su richiesta. / Para alturas bajo gancho superiores, otros alcances y trepado en el interior del edificio, consultar. / Outras alturas de elevação, comprimentos de lança e subida no edifício: sob consulta. / Другие высоты подъема, длины стрелы и самоподъем в здании – по запросу.

		280 EC-H 16 FR.tronic®											
m	r	m/kg	m/kg										
			20,0	25,0	30,0	35,0	40,0	45,0	50,0	55,0	60,0	65,0	70,0
70,0	(r=71,6)	2,6-19,0 14000	13230	10220	8230	6820	5760	4940	4280	3750	3300	2920	2600
65,0	(r=66,6)	2,6-19,8 14000	13820	10690	8620	7150	6050	5190	4510	3960	3490	3100	
60,0	(r=61,6)	2,6-18,3 16000	14460	11200	9040	7510	6360	5470	4760	4180	3700		
55,0	(r=56,6)	2,6-19,0 16000	15060	11680	9440	7850	6660	5740	5000	4400			
50,0	(r=51,6)	2,6-19,5 16000	15570	12080	9770	8130	6910	5960	5200				
45,0	(r=46,6)	2,6-19,9 16000	15890	12340	9990	8320	7070	6100					
40,0	(r=41,6)	2,6-20,2 16000	16000	12550	10160	8470	7200						

LM1

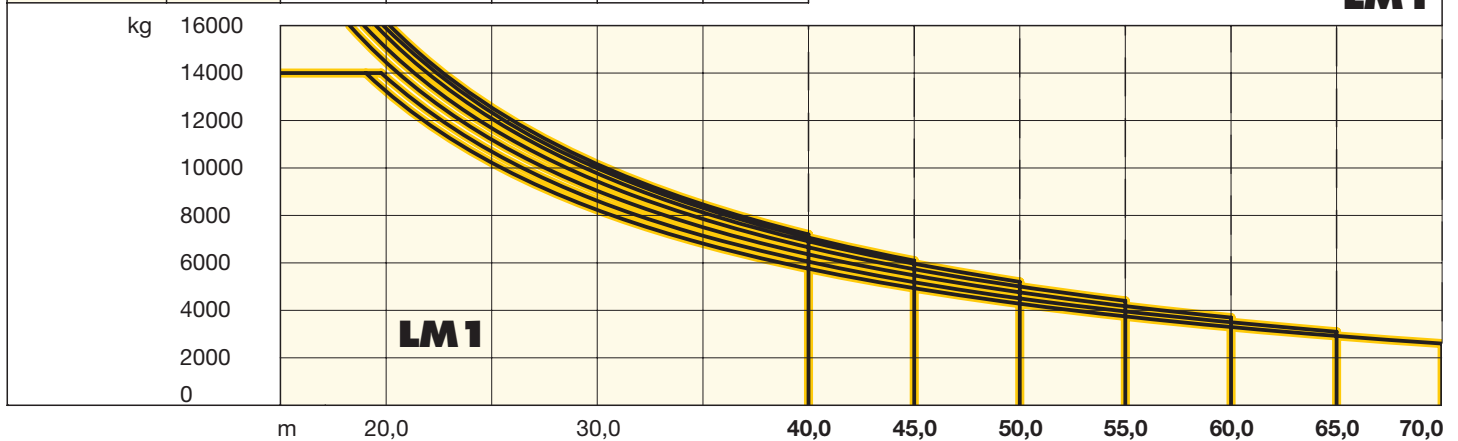

Antriebe FR.tronic®/Litronic®

Driving units / Mécanismes d'entraînement
Meccanismi / Mecanismos / Mecanismos / Приводы

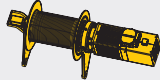

↔ **stufenlos** / stepless / régl. continu
regl. progressiva / sin escalones / sem degraus
бесступенчатый

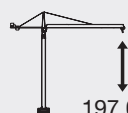
65 kW FU WIW 280 MZ 404	5 Lagen Layers Couches Avvolgimenti Camadas Capas Слоёв	1	16000	0 ↔ 21
 197,0 m			3300	0 ↔ 72

max. 393,0 m**

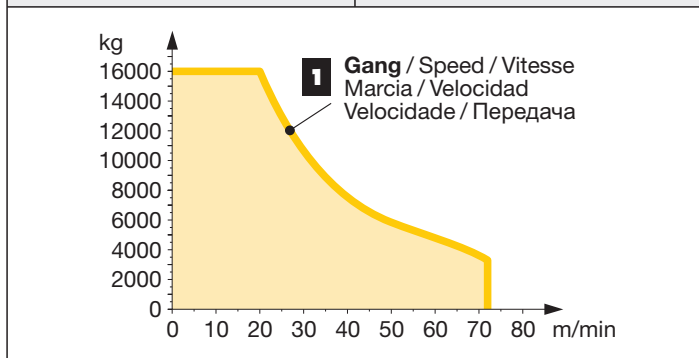

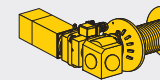

↔ **stufenlos** / stepless / régl. continu
regl. progressiva / sin escalones / sem degraus
бесступенчатый

65 kW FU WIW 280 VZ 405	5 Lagen Layers Couches Avvolgimenti Camadas Capas Слоёв	1	16000	0 ↔ 21
 219,0 m			3300	0 ↔ 73
		2	9400	0 ↔ 34
			1100	0 ↔ 128

max. 437,0 m**

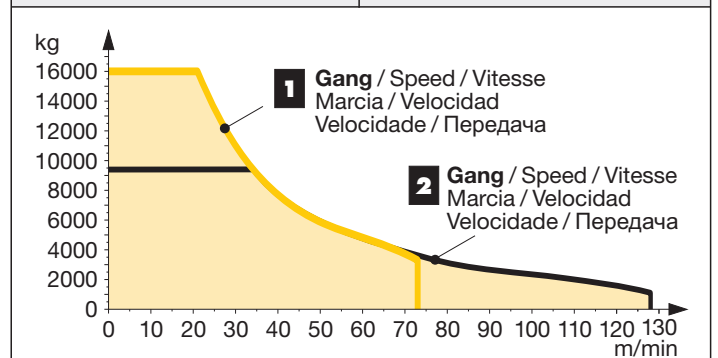

** Weitere Hublastdaten: siehe Betriebsanleitung. / Further hoist load data: see instruction manual. / Autres données de la charge de levage: voir manuel d'instruction. / Altri dati sui carichi sollevati: consultare il manuale d'istruzione. / Alturas bajo granchos superiores según manual. / Outras tabelas de carga: consultar manual de instruções. / Другие данные по весу поднимаемых грузов: см. инструкцию по эксплуатации.

Ausladung und Tragfähigkeit

Radius and capacity / Portée et charge / Sbraccio e portata
Alcances y cargas / Alcance e capacidade de carga / Вылет и грузоподъемность

		280 EC-H 16 Litronic®											
m	r	m/kg	m/kg										
			20,0	25,0	30,0	35,0	40,0	45,0	50,0	55,0	60,0	65,0	70,0
70,0	(r=71,6)	2,6-21,3 14000	14000	11640	9410	7820	6640	5720	4980	4380	3880	3460	3100
65,0	(r=66,6)	2,6-22,3 14000	14000	12270	9930	8270	7030	6060	5290	4670	4140	3700	
60,0	(r=61,6)	2,6-20,7 16000	16000	12890	10450	8710	7410	6410	5600	4950	4400		
55,0	(r=56,6)	2,6-21,4 16000	16000	13460	10920	9110	7760	6720	5880	5200			
50,0	(r=51,6)	2,6-22,3 16000	16000	14100	11450	9570	8160	7070	6200				
45,0	(r=46,6)	2,6-22,9 16000	16000	14510	11800	9860	8420	7300					
40,0	(r=41,6)	2,6-23,3 16000	16000	14800	12040	10070	8600						

LM1 + LM2

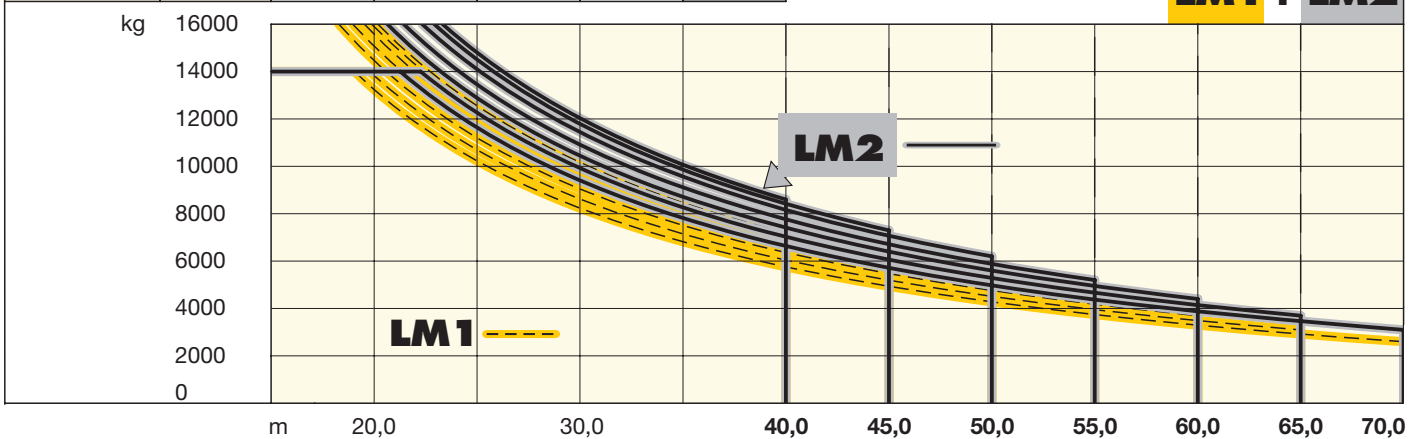

Antriebe FR.tronic®/Litronic®



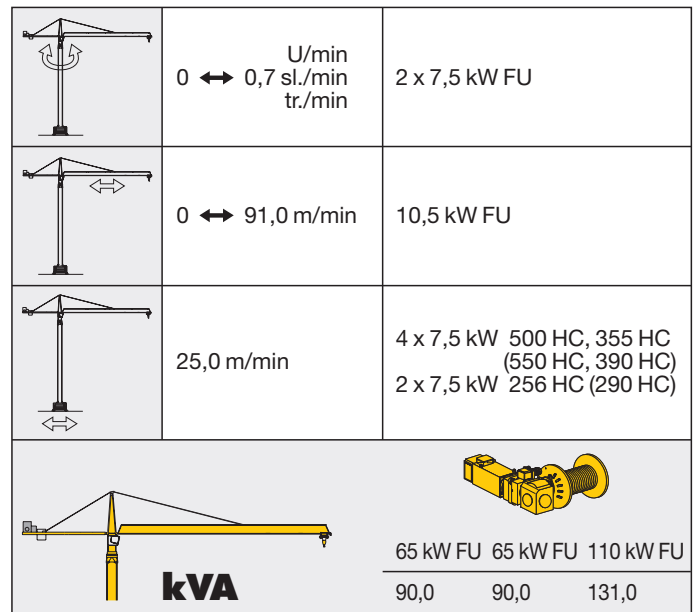
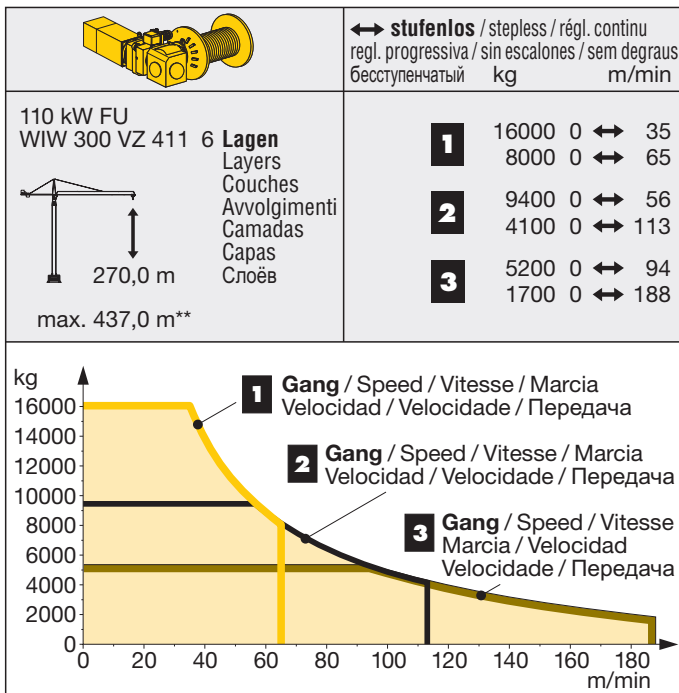







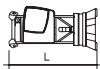

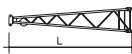

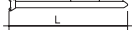



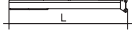

















Driving units / Mécanismes d entraînement
Meccanismi / Mecanismos / Mecanismos / Приводы











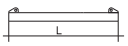

LM 2 Abweichende Geschwindigkeiten und Betriebsbedingungen.
Variant speeds and service conditions. / Vitesses et conditions de
fonctionnement différentes. / Differenti velocità e condizioni di
funzionamento. / Otras velocidades y características de funcio-
namiento. / Outras velocidades e características de funciona-
mento. / Нестандартные скорости и условия эксплуатации.

Litronic: kVA reduzierbar bei zu geringer Netz-Anschluss-
leistung, siehe BAL. / kVA can be reduced in case of too little power of
the mains, see instruction manual. / kVA peut être réduit en cas de trop
faible puissance du réseau, voir manuel d'instruction. / kVA riducibili in
caso di potenza di rete ridotta (si veda manuale uso e manutenzione) /
kVA variable para potencia de red demasiado pequeña, ver Manual de
instrucciones. / kVA reduzível no caso de capacidade da rede elétrica
muito baixa, ver manual de instruções. / Количество kVA может быть
сокращено до минимальной общей потребляемой мощности, см.
инструкцию по эксплуатации.

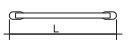
Montagegewichte: siehe Betriebsanleitung. / Erection weights: see instruction manual. / Poids de montage: voir manuel de service. / Pesi di montaggio: vedere manuale d'uso. / Peso para el montaje: según manual. / Pesos de montagem: vejã-se as instruções p. uso. / Масса монтируемых частей: см. инструкцию по эксплуатации.

Kranoberteil		Upper part of crane / Partie supérieure de grue / Parte superiore della gru Parte superior grúa / Parte superior do guindaste / Верхняя часть крана	L (m)	B (m)	H (m)	kg*			
Pos. Anz. Item Qty. Rep. Qte. Voce Qta. Pos. Cant. Ref. Cant. Поз. Кол-во		Drehbühne / Slewing platform / Ensemble mât-cabine / Piattaforma girevole / Conjunto plataforma de giro / Plataforma giratória / Поворотная платформа							
1	1		5,49	2,74	2,68	10120			
2	1	Turmspitze / Tower head section / Porte-flèche / Testa porta-braccio / Cabeza de torre / Cabeça de arapio de lança / Оголовок башни							
			9,09	1,70	1,92	2800			
3	1	Gegenausleger-Kopfstück / Counter-jib head / Pointe de contre-flèche / Testa di controbraccio / Tramo punta de contrapluma / Cabeça de contra-lança / Концевая секция консоли противовеса							
			8,48	2,45	0,92	3050			
4	1	Gegenausleger-Anlenkstück / Counter-jib heel section / Pied de contre-flèche / Settore articolato di controbraccio / Tramo primero-contrapluma / Base articulada da contra-lança / Корневая секция консоли противовеса							
			8,44	1,77	0,92	2800			
5	1	Gegenausleger-Zwischenstück / Intermediate counter-jib section / Élément interm. de contre-flèche / Spezzone di controbraccio / Tramo intermedio de contrapluma / Peça suplementar da contra-lança / Промежуточная секция консоли противовеса							
			5,22	1,76	0,92	1550			
6	1	Ausleger-Anlenkstück / Jib heel section / Pied de flèche / Sezione articolata braccio / Pluma tramo primero / Base articulada de lança / Корневая секция стрелы							
			12,26	1,86	1,96	① 3300			
7	1	Ausleger-Zwischenstück / Intermediate jib section / Élément intermédiaire de flèche / Sezione intermedia braccio / Tramo intermedio pluma / Peça suplementar da lança / Промежуточная секция стрелы							
1	10,26		1,63	1,87	②+③ 1950				
1	12,28		1,63	1,86	④ 2260				
1	5,32		1,63	1,86	⑤ 820				
1	10,27		1,63	1,86	⑥ 1250				
1	10,26	1,63	1,84	⑦ 840					
8	1	Ausleger-Kopfstück / Jib head section / Pointe de flèche / Punta braccio / Tramo punta de pluma / Cabeça de lança / Концевая секция стрелы							
			1,70	1,88	2,05	⑧ 280			
9	1	Laufkatze und Lasthaken / Trolley and hook / Chariot de distribution et crochet / Carrello con gancio / Carrito y gancho / Carro de ponte e gancho / Грузовая тележка и грузовой крюк							
			1,89	1,83	1,57	1520			
10	1	Hubwerkseinheit / Hoist gear unit / Treuil de levage / Gruppo meccanismo sollevamento / Mecanismo de elevación / Grupo de mecanismo elevatório / Блок грузовой лебедки			280 VZ				
			2,30	2,70	1,65	5800			
Turm		Tower / Mât / Torre Torre / Torre / Башня							
11	9	Turmstück / Tower section / Élément de mât / Elemento di torre / Tramo torre / Torre / Башенная секция			256 HC (290 HC)	4,14	2,30	2,30	2300
11	355 HC (390 HC)		6,28	2,45	2,45	5050			
13	500 HC (550 HC)		6,28	2,45	2,45	6490			
12	1	Turmstück lang / Long tower section / Élément de mât long / Elemento di torre, lungo / Tramo de torre largo / Peça de torre, comprida / Башенная секция, длинная			256 HC (290 HC)	12,42	2,30	2,30	5770
13	1	Grundturmstück / Base tower section / Mât de base / Elemento di torre base / Tramo base / Peça de base de torre / Секция основания			256 HC (290 HC)	8,85 (12,42)	2,30 (2,30)	2,30 (2,30)	4830 (7935)
Klettereinrichtung		Climbing equipment / Equipement de télescopage / Attrezzatura per allungamento della gru Equipo de trepado / Acesórios p. subida no edifício / Обойма наращивания							
14	1	Führungsstück kpl. / Guide section cpl. / Cage télescopique cpl. / Gabbia di sopraelevazione compl. / Torre de montaje completa / Peça de guia compl. / Направляющая секция в сб.			256 HC (290 HC)	8,39	2,68	2,58 (3,04)	4600
			355 HC (390 HC)	12,39	2,75	1,58	8950		
			500 HC (550 HC)	12,39	2,75	1,58	8950		
15	1	Hydraulikanlage, Stütz- und Klettertraverse / Hydraulic unit, supporting and climbing cross members / Système hydraulique avec traverses d'appui et de télescopage / Sistema hidráulico, travessa di appoggio e allungamento gru / Sistema hidráulico con travessa de apoio y trepado / Instalação hidráulica, travessa de arapio e subida / Гидроагрегат, стойка-упор и трассера обоймы наращивания			256 HC (290 HC)	2,10	1,25	1,00	1150
			355 HC (390 HC)	2,10	1,10	1,00	1710		
			500 HC (550 HC)	2,10	1,10	1,00	1710		
Unterwagen		Undercarriage / Châssis / Carro Carro con mástil / Carro de guindaste / Опорная рама							
16	4	Ausgleichsschwinge mit Schwingenlager / Pivot for wheel box / Chape pour bogie / Bilanciere di equilibratura con cuscinetto bilanciante / Balancin / Balancim com suporte / Балансир с шарнирной опорой			355 HC (390 HC)	1,60	0,72	1,48	1390
			500 HC (550 HC)						
17	2	Fahrschemel mit Antrieb / Rail bogie with drive / Bogie moteur / Telaio con gruppo propulsore / Caja rodillo motriz / Quadro sem grupo de propulsão / Подрамник с приводом			256 HC (290 HC)	1,63 (1,46)	0,92 (0,84)	0,95 (0,87)	1690 (920)
4	355 HC (390 HC)		1,40	0,75	0,65	920			
4	500 HC (550 HC)		1,45	0,82	0,72	1690			
18	2	Fahrschemel ohne Antrieb / Rail bogie without drive / Bogie fou / Telaio senza gruppo propulsore / Caja rodillo conducido / Quadro com grupo de propulsão / Подрамник без привода			256 HC (290 HC)	1,37 (1,15)	0,62 (0,60)	0,95 (0,87)	1340 (880)
4	355 HC (390 HC)		1,10	0,60	0,65	880			
4	500 HC (550 HC)		1,30	0,40	0,72	1340			

Pos. Item Rep. Voce Pos. Ref. Pos.	Anz. Qty. Qte. Qta. Cant. Cant. Кол-во				L (m)	B (m)	H (m)	kg*	
19	1	Tragholm lang / Long support arm / Longeron long			256 HC (290 HC)	9,10 (11,85)	0,80 (0,82)	0,80 (0,80)	1650 (2200)
	2	Longherone lungo / Brazo soporte largo / Travessa comprida / Несущая балка, длинная			355 HC (390 HC)	11,82	0,92	0,93	3515
	2				500 HC (550 HC)	7,32	0,92	0,93	2330
20	2	Tragholm kurz / Short support arm / Longeron court			256 HC (290 HC)	4,45 (5,58)	0,77 (0,65)	0,77 (0,77)	800 (1035)
		Longherone corto / Brazo soporte corto / Travessa curta / Несущая балка, короткая			355 HC (390 HC)	5,74	0,80	0,90	1600
					500 HC (550 HC)	7,14	0,80	0,90	2135
21	2 + 2	Randträger / Border support / Traverse			256 HC (290 HC)	5,46 – 5,40	0,11 – 0,18	0,16 – 0,38	175 – 525
		Supporti base / Traviesa / Apoio de bordo			355 HC (390 HC)	(7,52 – 7,46)	(0,1 – 0,17)	(0,1 – 0,38)	(366 – 912)
		Стяжная балка			500 HC (550 HC)	7,30	0,14	0,14	340
						9,30	0,14	0,14	510
22	4	Stützholm / Support strut / Hauban de châssis			256 HC (290 HC)	4,14 (6,55)	0,18 (0,22)	0,25 (0,25)	320 (600)
		Correnti di appoggio / Tirante vertical / Travessa de apoio / Опорный подкос			355 HC (390 HC)	6,06	0,26	0,34	862
					500 HC (550 HC)	6,98	0,26	0,34	1140
23	1	Unterwagen-Turmstück / Undercarriage tower section / Mât de châssis / Elemento di torre del carro Tramo de carro / Peça de torre do chassis			256 HC (290 HC)	3,73 (6,70)	2,62 (2,53)	2,62 (2,53)	2550 (3800)
		Опорная башенная секция			355 HC (390 HC)	6,61	2,44	2,44	7475
					500 HC (550 HC)	6,61	2,44	2,44	7930
24		Kleinteile, Seile und Abspannungen / Small parts, ropes and holding bars			256 HC (290 HC)				
		Accessoires, câbles et tirants / Accessori, funi e attrezzi di ancoraggio			355 HC (390 HC)	9,00	1,60	1,00	4000
		Despieces, cables y tirantes / Acessórios, cabos e peças de ancoragem			500 HC (550 HC)				
		Мелкие детали, Канаты и Пристёжки							

() **Angaben in Klammern gelten für 8 m-Unterwagen.** / The data in brackets are valid for an undercarriage of 8 m. / Les données techniques indiquées entre parenthèses sont valables pour un châssis de 8 m. / Caratteristiche in (..) valgono per carro di 8 m. / Los datos entre paréntesis son válidos para carro de 8 m. / Características em (..) válidas pelo chassis de 8 m. / Данные в скобках относятся к 8-метровой опорной раме

* **Einzelgewichte.** / Single weights. / Poids individuels. / Singoli pesi. / Pesos unitarios. / Pesos de peças componentes. / Индивидуальный вес.

Konstruktionsänderungen vorbehalten! / Subject to alterations! / Sous réserves de modifications! / Reservato il diritto di modifiche strutturali! / ¡Sujeto a modificaciones! / Salvo modificação da construação! / Права на внесение конструкторских изменений сохраняются!

Sämtliche Angaben erfolgen ohne Gewähr. / This information is supplied without liability. / Ces renseignements sont sans garantie. / Tutte le indicazioni fornite senza garanzia. / Declinamos toda responsabilidad derivada de la información proporcionada. / Declinamos qualquer responsabilidade quanto à informação fornecida. / Все данные указаны без обязательств.

121 P – 5855 • EN 14439:2009 – DIN 15018-H1/B3 • BGL C.0.10.0280 • 04.10 / 7

Printed in Germany.